

# IP68 Protected DC Fan with PWM and Tach Output

## 09238RE-12Q/24Q (D-Type)

NMB

### General Specifications

**Motor Type:**

DC Brushless Motor

**Motor Protection:**

Auto Restart / Polarity Protection (Motor withstands reverse connection for positive and negative leads.)

**Insulation Resistance:**

10MΩ or over with a DC 500V Megger

**Dielectric Withstand Voltage:**

AC 500V 1min or AC 700V 1sec

**Allowable Ambient Temperature Range:**

-10°C ~ + 70°C (Operating)

-40°C ~ + 70°C (Storage)

(non-condensing environment)



\*For reference only. Please see fan outline for details

### Characteristic Curves

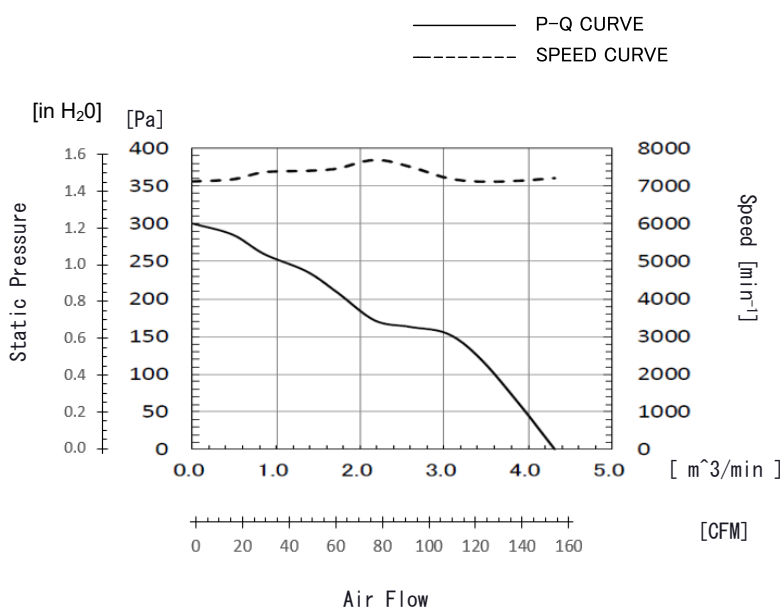

### Features

- DC axial fan with outstanding P-Q performance, IP68 protection, PWM speed control, and tach output
- IP68 with highest level of protection from water/dust ingress
- Outfitted with NMB precision machined stainless steel ball bearings for long life
- Ideal for applications such as EV chargers, PV inverters, energy storage, Bi-Directional chargers and many other outdoor applications

### Life Expectancy L10

100,000 Hours at 25 Celsius

\*Fan life expectation is based on free air operation at 25°C, rated voltage, and indoor benign lab environment

\*1: Values in Free Air

### Specifications

MODEL	Rating Voltage (V)	Operating Voltage (V)	Current		Input Power		Speed (min <sup>-1</sup> )*1	Max. Air Flow		Max. Static Pressure		Noise (dB)*1	Mass (g)
			Avg (A)*1	Max (A)*1	Avg (W)*1	Max (W)*1		(CFM)	(m <sup>3</sup> /min)	(in H <sub>2</sub> O)	(Pa)		
			(A)*1	(A)*1	(W)*1	(W)*1		(m <sup>3</sup> /min)	(Pa)	(Pa)			
09238RE-12Q-GUD-1	12	7.0 to 13.2	2.41	3.14	28.92	37.68	7,200	152.6	4.32	1.20	300	62.5	270
09238RE-24Q-GUD-2	24	14.0 to 26.4	1.13	1.47	27.12	35.28	7,200	152.6	4.32	1.20	300	62.5	270

## PWM Specifications

### Connection

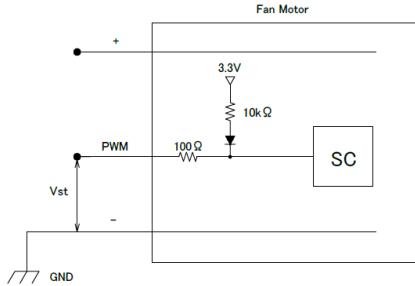

### 1. PWM Control

- Vst = Low Level (0V~0.4V) → Stop (On Duty 0%)
- Vst = High Level (4.5V~5.0V) → Full Speed (On Duty 100%)
- Vst = Open → Full Speed

### 2. PWM Duty & PWM Input Pulse

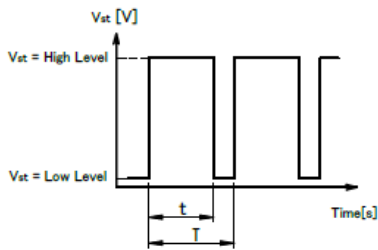

PWM Duty means that a ratio of high level time (t)/PWM Input Pulse(T).

$$(t/T) \times 100 : \text{On Duty } 0\% \sim 100\%$$

$$\text{PWM Frequency } f = 25 \pm 5 [\text{kHz}]$$

### 3. The condition for PWM control are as follows

- Please install the fan in your system when inputting the PWM function. If the PWM duty is very low, or affected by external factors, the fan might not start up under your system conditions
- Run the fan at rated voltage only during PWM operation
- Please start the fan with duty cycle of 20% or more at 25kHz.[At rated voltage input, Ambient temperature 25°C]

## PWM Characteristic Curve

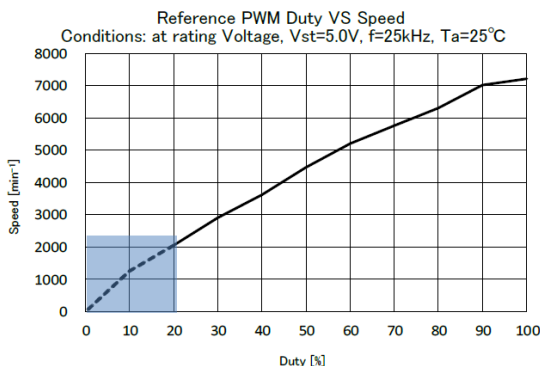

## TACHO Specifications

### Tachometer Signal

1. Output Circuit: Open Drain
2. Specification
  - Absolute Maximum Ratings at Ta=25°C
  - V<sub>DSmax</sub>: +15V
  - I<sub>Dmax</sub>: 5mA[V<sub>DS(sat)</sub>max=1.5V]

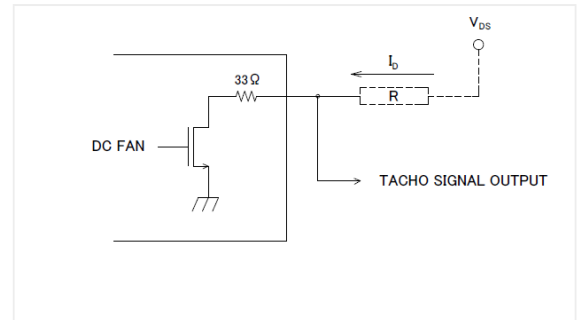

### 3. Output Waveform: At Rated Voltage Output Signal Voltage

#### Case-1

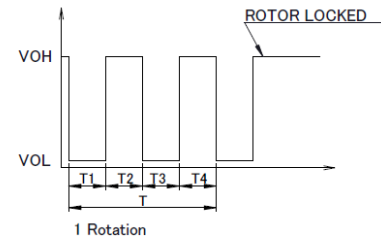

#### Case-2

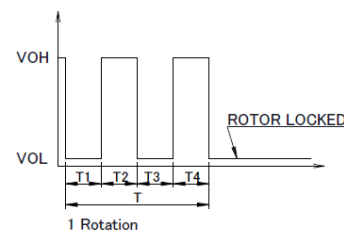

- 1) When the rotor is locked at VOH position of signal, signal stays at VOH position.
- 2) When the rotor is locked at VOL position of signal, signal stays at VOL position.
- 3)  $T = T1 + T2 + T3 + T4 = 60/m = 1 \text{ rotation}$   
 m: Fan Speed (min<sup>-1</sup>)  
 Tacho Duty Cycle=50%±10%

For 12 V DC Model

## PWM Specifications

### Connection

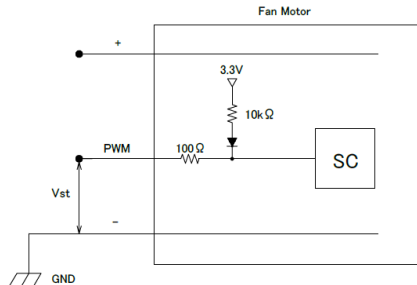

#### 1. PWM Control

- Vst = Low Level (0V~0.4V) → Stop (On Duty 0%)
- Vst = High Level (4.5V~5.0V) → Full Speed (On Duty 100%)
- Vst = Open → Full Speed

#### 2. PWM Duty & PWM Input Pulse

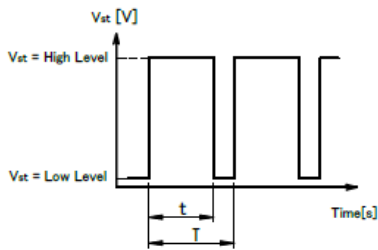

PWM Duty means that a ratio of high level time (t)/PWM Input Pulse(T).

$$(t/T) \times 100 : \text{On Duty } 0\% \sim 100\%$$

$$\text{PWM Frequency } f = 25 \pm 5 [\text{kHz}]$$

#### 3. The condition for PWM control are as follows

- Please install the fan in your system when inputting the PWM function. If the PWM duty is very low, or affected by external factors, the fan might not start up under your system conditions
- Run the fan at rated voltage only during PWM operation
- Please start the fan with duty cycle of 20% or more at 25kHz.[At rated voltage input, Ambient temperature 25°C]

## PWM Characteristic Curve

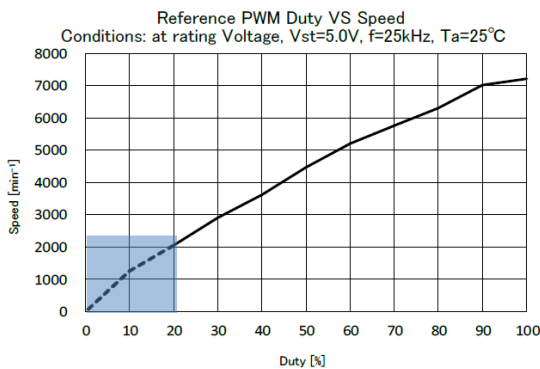

## TACHO Specifications

### Tachometer Signal

1. Output Circuit: Open Drain
2. Specification  
*Absolute Maximum Ratings at Ta=25°C*  
 $V_{DSmax}: +30V$   
 $I_{Dmax}: 5mA [V_{DS(sat)}max=1.5V]$

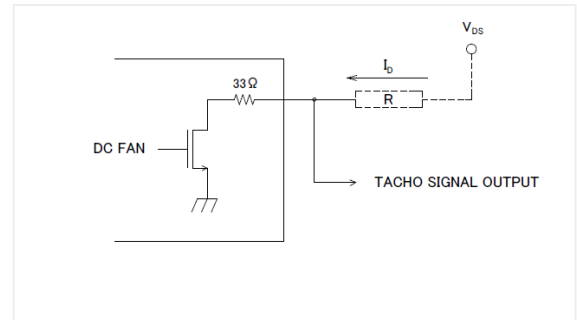

#### 3. Output Waveform: At Rated Voltage Output Signal Voltage

##### Case-1

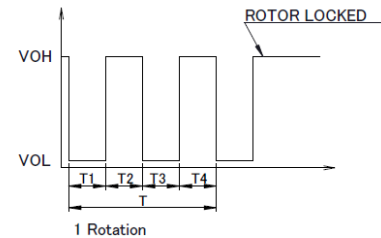

##### Case-2

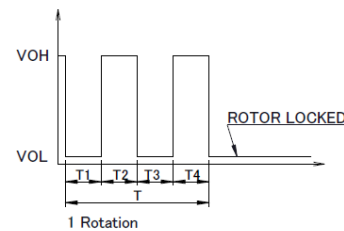

- 1) When the rotor is locked at VOH position of signal, signal stays at VOH position.
- 2) When the rotor is locked at VOL position of signal, signal stays at VOL position.

$$3) T=T1+T2+T3+T4=60/m=1 \text{ rotation}$$

$$m: \text{Fan Speed (min}^{-1}\text{)}$$

$$\text{Tacho Duty Cycle}=50\% \pm 10\%$$

### For 24 V DC Model

# IP68 Protected DC Fan with PWM and Tach Output 09238RE-12Q/24Q (D-Type)

# NMB

## Outlines

(Name Plate)

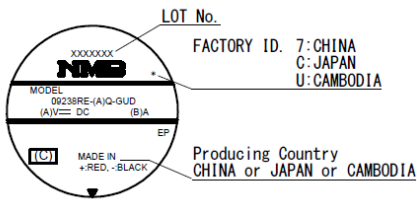

09238RE-12Q-GUD-1  
 (A): 12  
 (B): 3.14  
 (C): 1  
 09238RE-24Q-GUD-2  
 (A): 24  
 (B): 1.47  
 (C): 2

Safety Marking	09238RE-12Q-GUD-1	09238RE-24Q-GUD-2
cULus(File No.E89936)	Coming Soon	Coming Soon
CE	None	None
VDE(File No.1507300)	None	None

## Materials

**Casing:** Plastic (Black UL 94V-0)

**Impeller:** Plastic (Black UL 94V-0)

**Bearing:** Stainless Steel Ball Bearing

**Lead Wire:** UL3443 AWG24  
or equivalent for

Red (+)  
 Black (-)  
 White (Tach)  
 Brown (PWM)

(Outline)

FLANGE TYPE

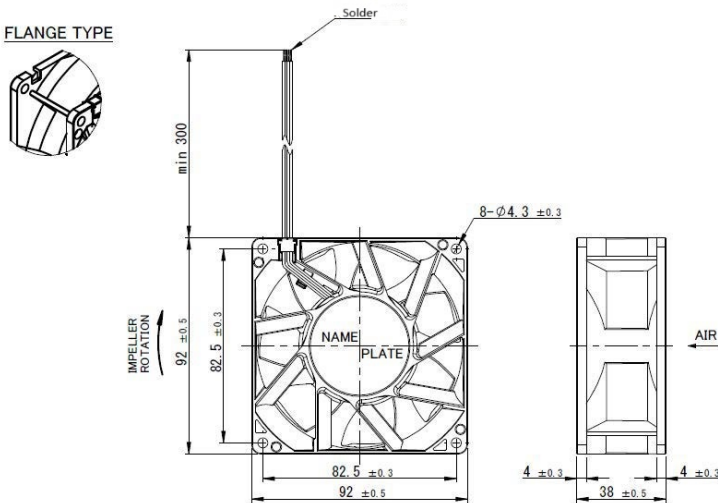

(Panel Out-line)

